

SIMONSWERK

BAKA®

butt hinge H 180

for unrebated timber door leaves (Berliner hinge)

hinge

Technical details

knuckle length	180,0 mm
h x b frame leaf	90,0 x 40,0 mm
material thickness	3,5 mm
screws	5,0 x 50,0 mm
h x b door leaf	90,0 x 37,0 mm
pin diameter	12,0 mm

Note

Version with loose pin and level straps.

Use of washers or ball bearings obligatory. These are not included in the delivery.

Combination

accessories	iron washer 12 mm
	brass washer 12 mm
	ball bearing 12 mm

Items (DIN reference: DIN right and left hand)

Finish(es)	galvanised
packing unit	pack of 10
item number	5 130603 0 01006

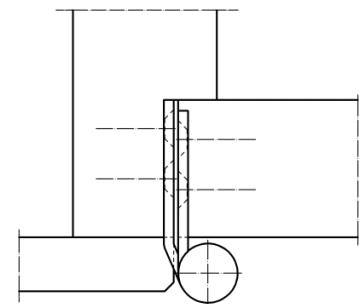
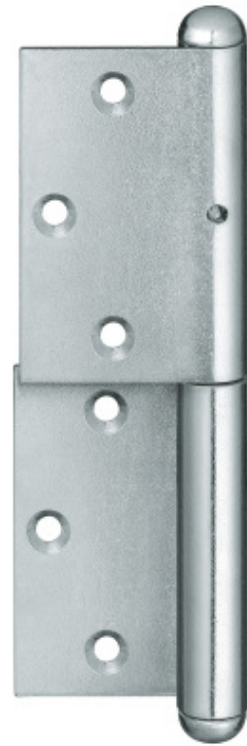

cross section