

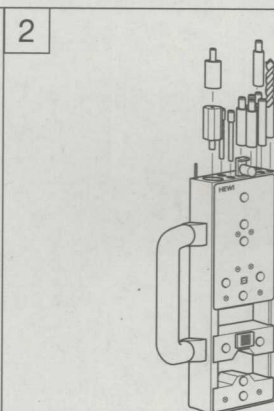

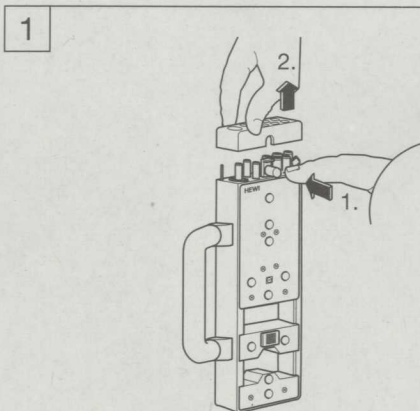







Bohrlehre BL 305.6.10 U
Installation jig BL 305.6.10 U



-  ø 22 mm KABA (Schweiz | Switzerland)
-  ø 17 mm Profilzylinder (PZ) | Euro cylinder
-  ø 10 mm Zentrierdorne | centering pin
-  ø 9 mm Zentrierdorne | centering pin
-  ø 8,5 mm Zentrierdorne | centering pin
(Österreich | Austria)

-  ø 8 mm Zentrierdorne | centering pin
-  ø 8 mm Zentrierdorne | centering pin
-  ø 7 mm Zentrierdorne | centering pin
-  ø 6 mm Zentrierdorne | centering pin
-  ø 5 mm Zentrierdorne | centering pin
-  ø 7 mm Bohrer | drill bit

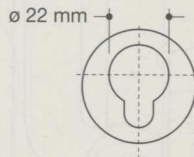
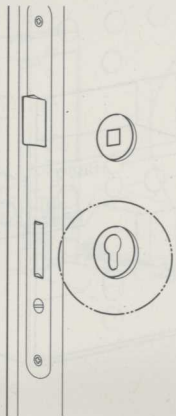
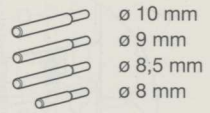
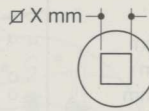
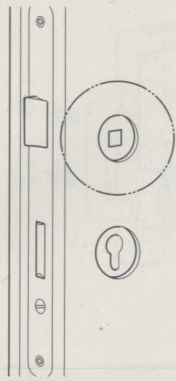

KABA
 $\varnothing 22 \text{ mm}$

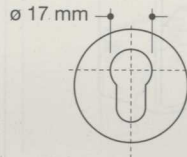

Profilzylinder (PZ)
Euro cylinder
 $\varnothing 17 \text{ mm}$

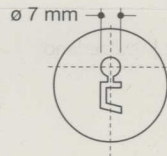

Buntbart (BB)
Lever key
 $\varnothing 7 \text{ mm}$

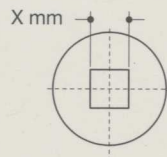

WC (NR/FB)
vacant/engaged
 $\varnothing 8 \text{ mm}$
 $\varnothing 7 \text{ mm}$
 $\varnothing 6 \text{ mm}$
 $\varnothing 5 \text{ mm}$

1

ø 10 mm
ø 9 mm
ø 8,5 mm
ø 8 mm

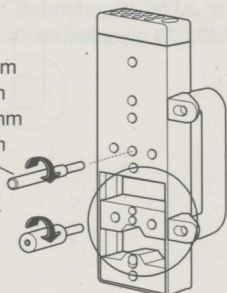

2a

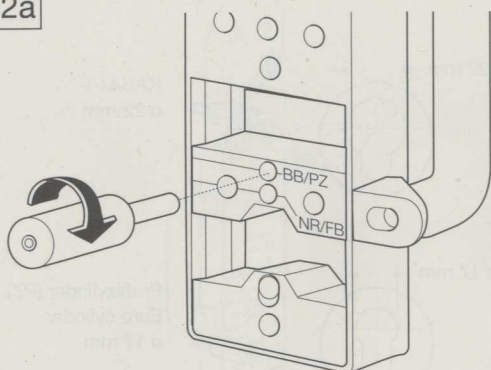

- Buntbart (BB)
Lever key
- Profilzylinder (PZ)
Euro cylinder
- KABA

2b

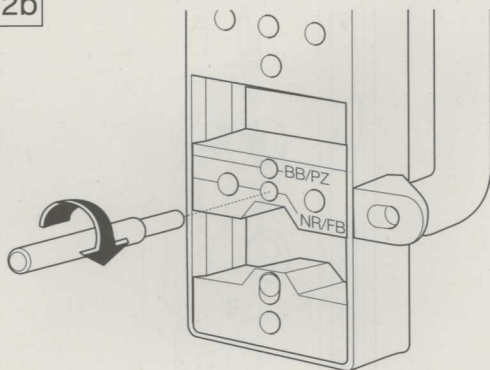

- WC (NR/FB)
vacant/engaged

1

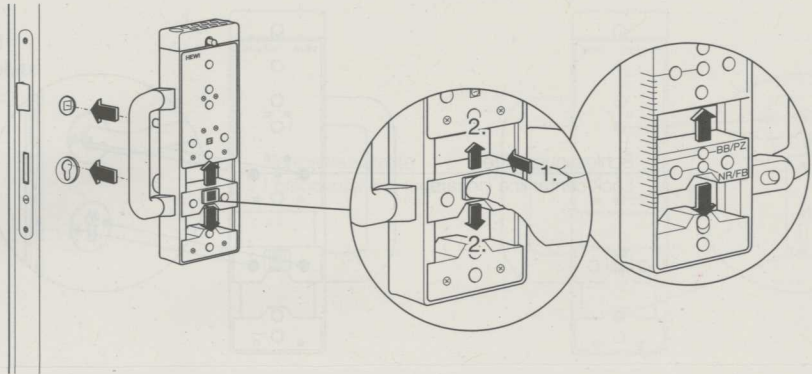

2

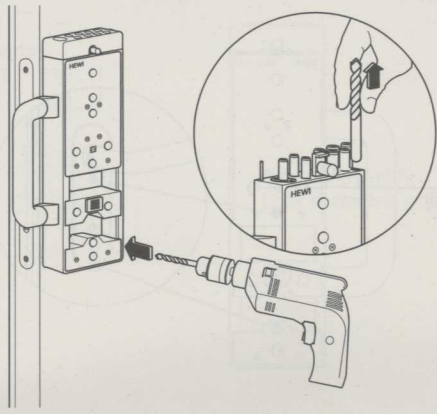

3

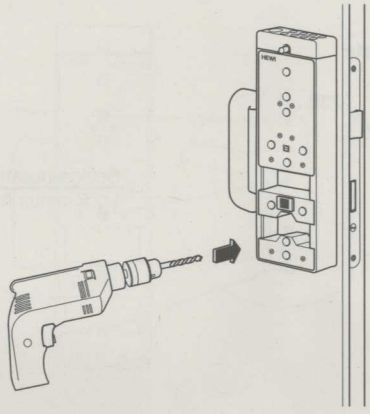

 Achtung!

Nicht in oder durch den Schlosskasten bohren!

 D

 Very important to note!

Do not drill into or through the lockcase!

 GB

Auswahl Bohrbilder für Schilder und Rosetten
assortment pattern for backplate and roses

Rosette

roses

305...

306...

307...

308...

Schlossnussmitte
Lock center line (square)

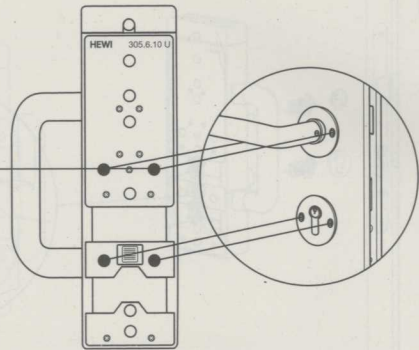

Schild
backplate

217...R

230...R 230...H

270...R

285...R

Schlossnussmitte
Lock center line (square)

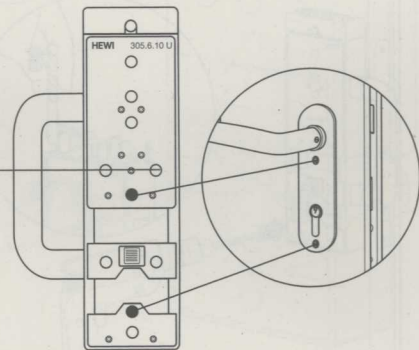

Schutzbeschlag (Kurzschild)
Security backplate (short)

sg...9...

mit Bohrer \varnothing 10,5 mm nachbohren.
redrill with drill bit \varnothing 10,5 mm.

Schlossnussmitte
Lock center line (square)

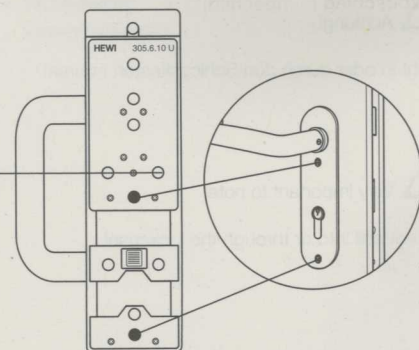

**Schild
backplate**
230...E

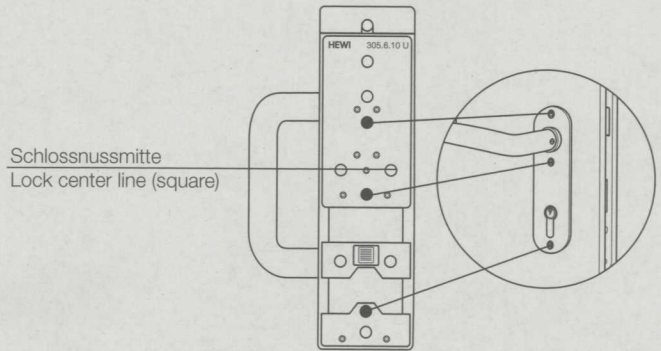

**Schild
backplate**
235...R 219...H
220...H

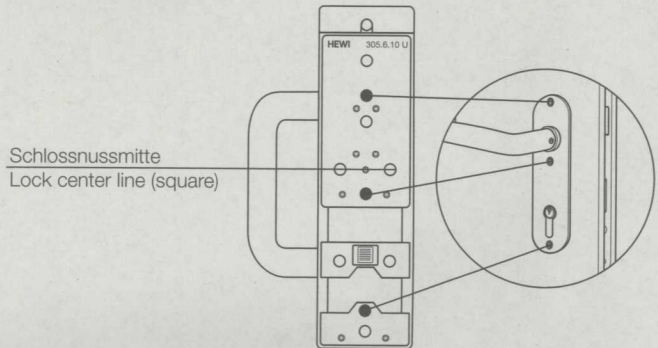

Schutzbeschlag (Langschild)
Security backplate (long)
sg...7...

mit Bohrer \varnothing 10,5 mm nachbohren.
redrill with drill bit \varnothing 10,5 mm.

